

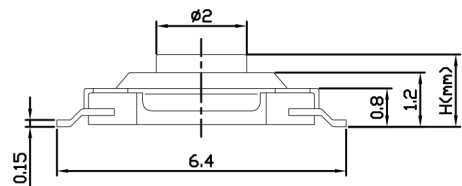

RoHS
Compliant
2002/95/EC

REV.	ECN. NO.	APPD.

DIMENSIONS



CIRCUIT DIAGRAM

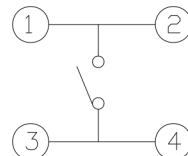
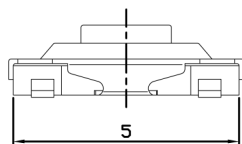

PRODUCT IMAGE

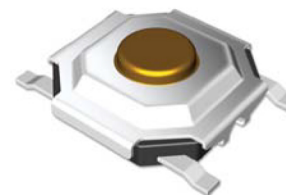

MODEL CODE

AT-1187 - - -

	H	Cover Shape		Knob Color	
-	1.5	S	Square	SR	Silver
A	4.3	R	Circular	GD	Gold
B	1.7				
C	1.6				
D	2.3				
E	3.0				

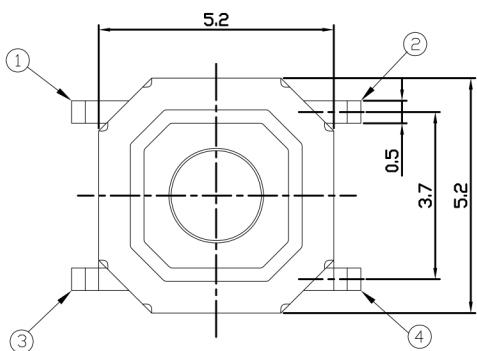

P.C.B MOUNTING PATTERN DIMENSION

The following soldering patterns are recommended for reflow soldering

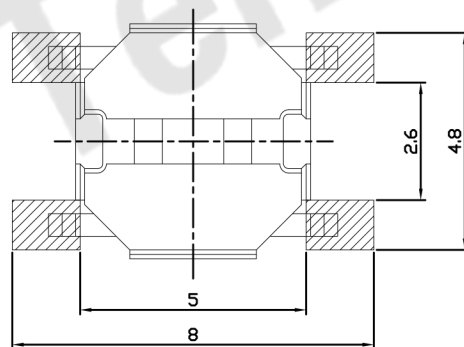
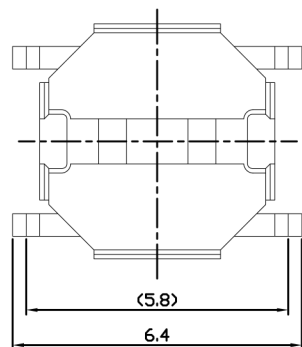

ELECTRO-MECHANICAL CHARACTERISTICS

Refer to additional specifications

Rating	DC 12V 50mA	
Contact Resistance	100mΩ Max.	
Travel	0.25 ± 0.1mm	
Operating Force	160±30gf	250±50gf
Operating Life(cycles)	100,000	

.X ±0.2	X. ±2'	UNITS mm
		MAT'L SEE NOTE
		FINISH SEE NOTE
		Q'TY

THESE DRAWINGS AND SPECIFICATIONS ARE THE PROPERTY OF ACCURATE INNOVATECH INC AND SHALL NOT BE REPRODUCED, COPIED OR USED IN ANY MANNER WITHOUT THE PRIOR WRITTEN CONSENT OF ACCURATE INNOVATECH INC.



东莞市腾兴电子有限公司

TITLE: TACT SWITCH	PART NO.: AT-1187-S 方盖SERIES
DR: Ricky 2014/03/31	DWG NO.: ASI-1187-S
CHKD: Ricky 2014/03/31	SCALE SHEET REV. CUSTOMER DRAWING
APPD:	1:1 1/1 A